

# HEXORA

LA LUMIÈRE AU SERVICE DU DÉTAIL

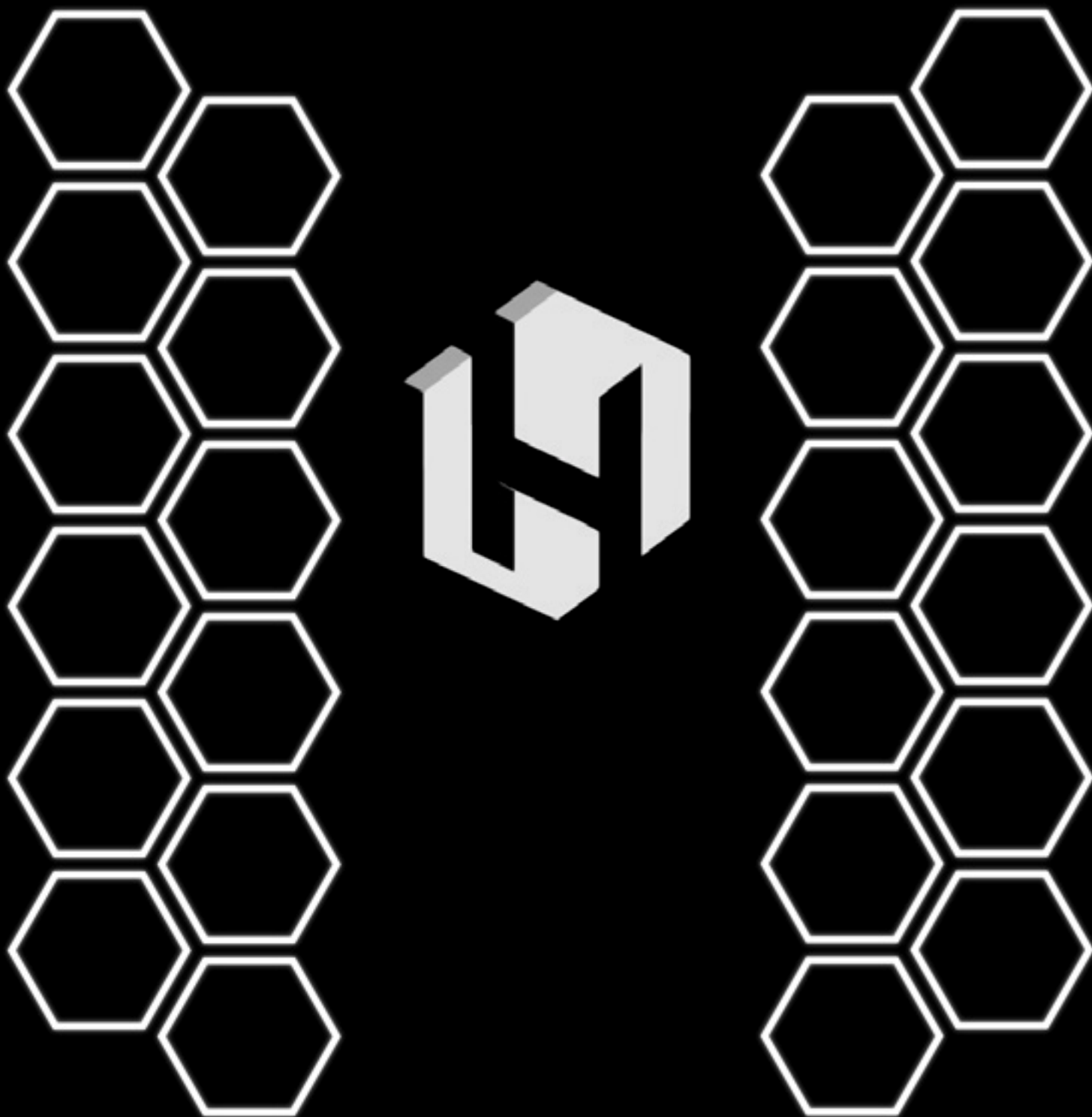

CATALOGUE 2026 / 2027

UNE MARQUE DE CONCEPT LIGHT

# SOMMAIRE

---



1 Nids d'abeilles - Gamme RGB



5 Nids d'abeilles - Gamme SHX



13 Cadres H



21 Tunnels



22 Customisables



24 Accessoires



26 Fonctionnement



27 Sur-mesure



30 Mise en lumière



34 Contact



# HEXORA - NID D'ABEILLES

Gamme RGB



CL-Detailing LED - RGBHEX001  
11W - 12V - 987 x 894 mm - aluminum

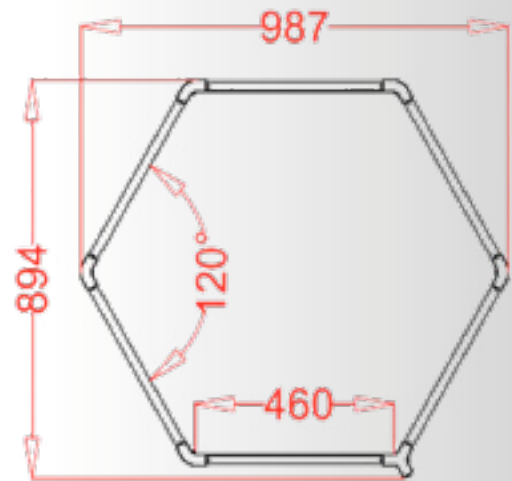

CL-Detailing LED - RGBHEX002  
20W - 12V - 1735 x 987 mm - aluminum

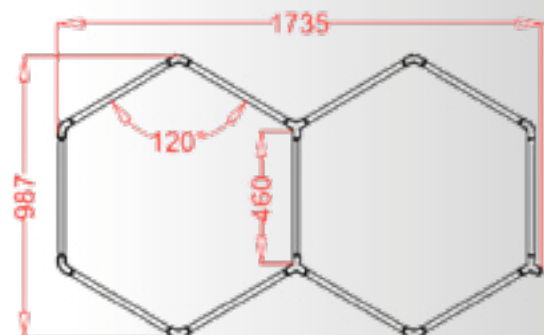
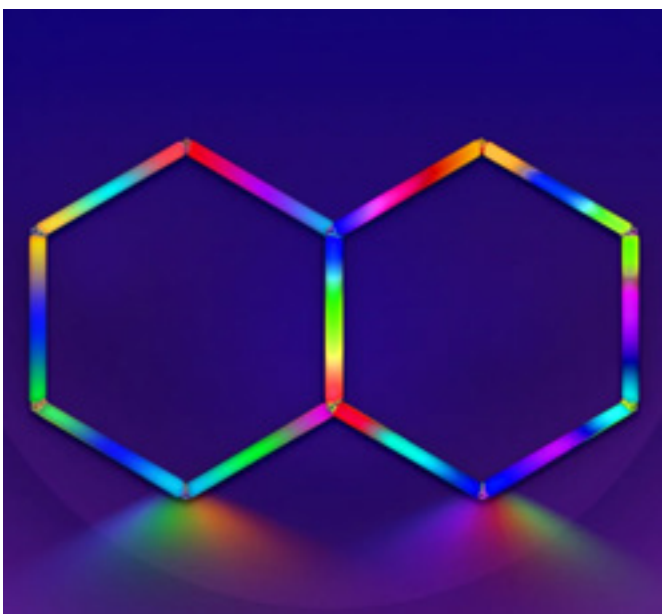

# HEXORA - NID D'ABEILLES

Gamme RGB



CL-Detailing LED - RGBHEX003  
27W - 12V - 1707 x 1715 mm - aluminum

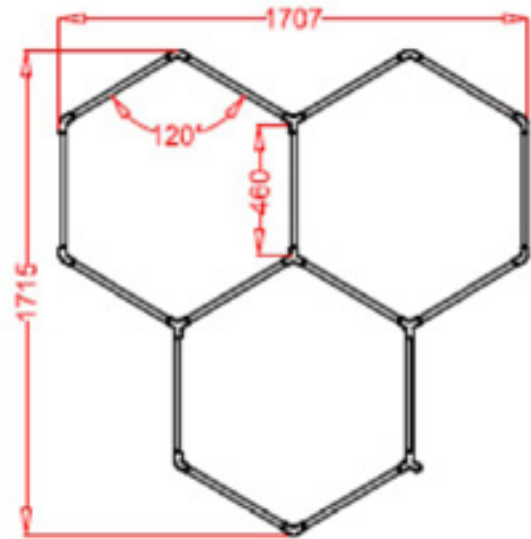

CL-Detailing LED - RGBHEX004  
42W - 12V - 2548 x 1715 mm - aluminum

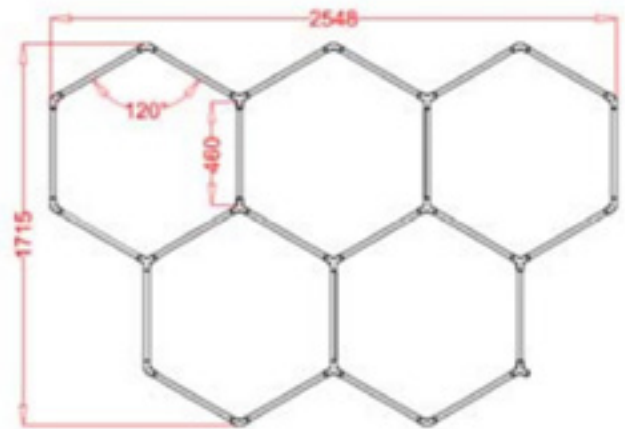

# HEXORA - NID D'ABEILLES

## Gamme RGB



CL-Detailing LED - RGBHEX005  
42W - 12V - 1707 x 2444 mm - aluminum

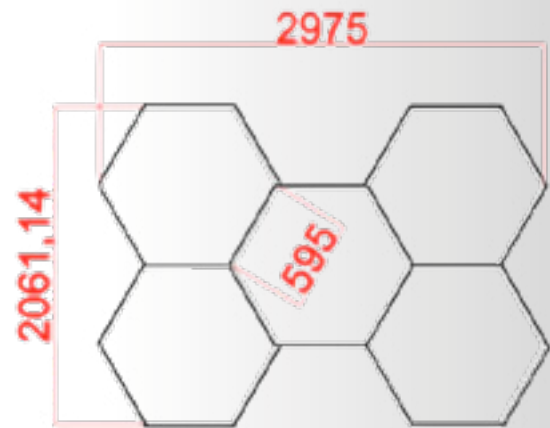
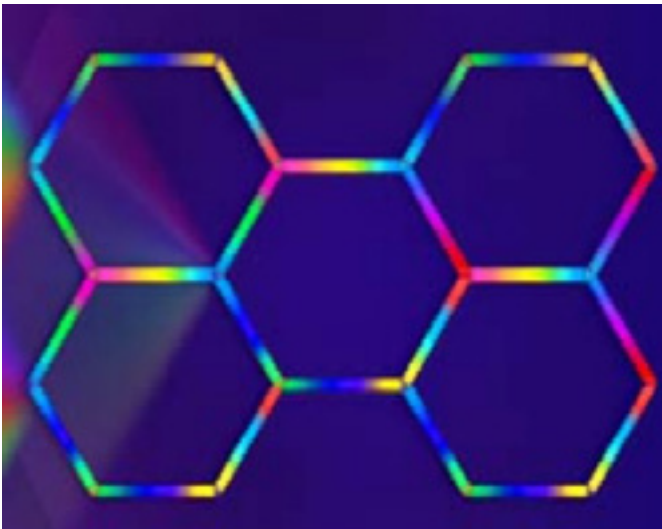

CL-Detailing LED - RGHEXO B06  
63W - 12V - 2576 x 2444 mm - aluminum

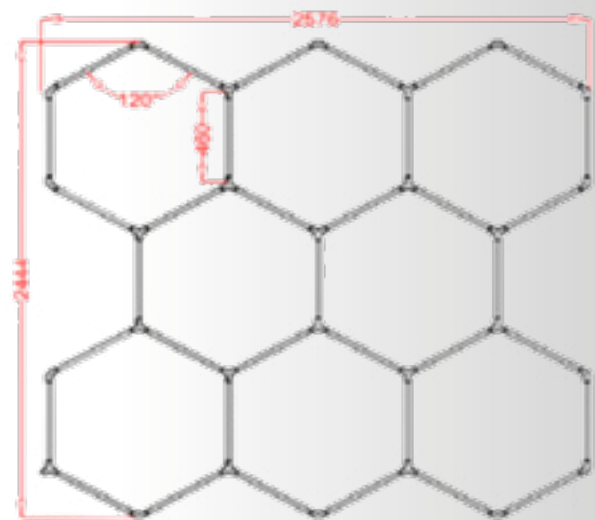
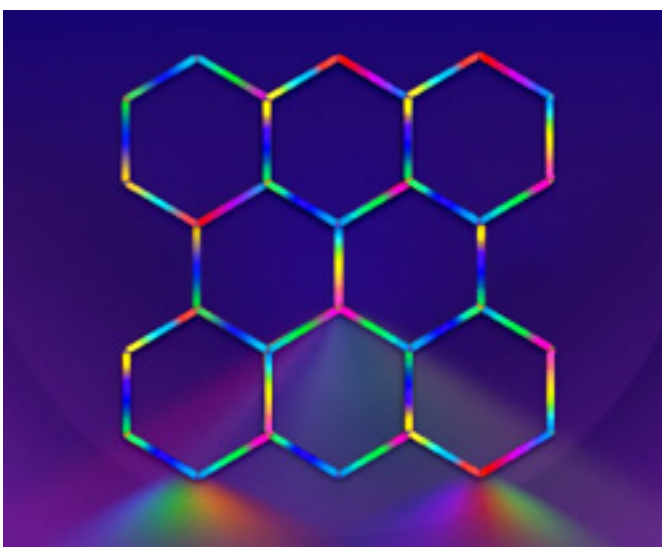

# HEXORA - NID D'ABEILLES

Gamme RGB



CL-Detailing LED - STHEXO1028T Duo Clor  
4840 x 2433 mm

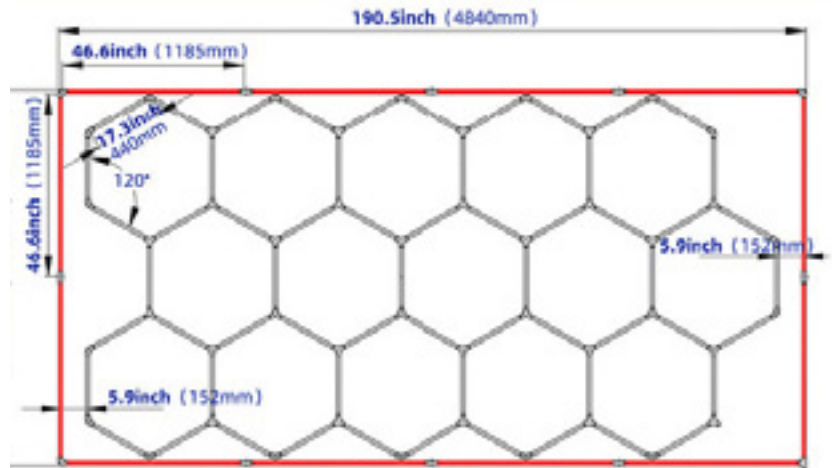

CL-Detailing LED HEXO - Dual Color Red  
4840 x 2433 mm

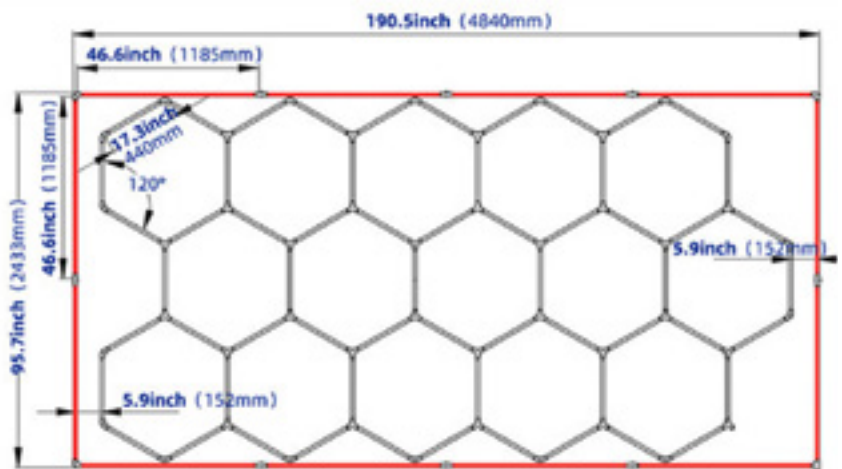

# HEXORA - NID D'ABEILLES

Gamme SHX



## CL-Nid d'abeilles SHXHEX001

120W - 120 lm/W - 2100 x 2100 x 20 mm - IP 44 - 6500°K

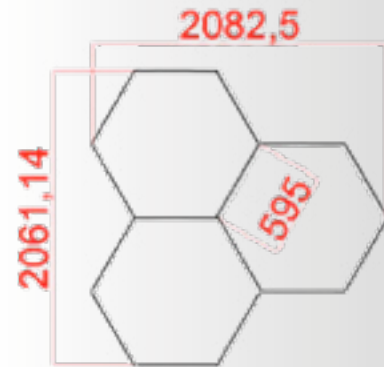

## CL-Nid d'abeilles SHXHEX004

192W - 120 lm/W - 2100 x 3000 x 20 mm - IP 44 - 6500°K

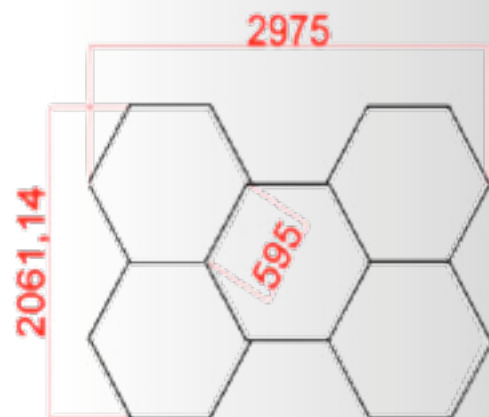

# HEXORA - NID D'ABEILLES

## Gamme SHX



### CL-Nid d'abeilles SHXHEX006

280W - 120 lm/W - 3000 x 3100 x 20 mm - IP 44 - 6500°K

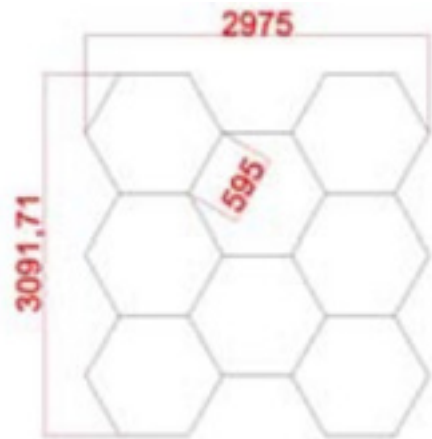

### CL-Nid d'abeilles SHXEXO002

128W - 120 lm/W - 3100 x 1200 x 20 mm - IP 44 - 6500°K



# HEXORA - NID D'ABEILLES

Gamme SHX



CL-LED géométrique polygonal STHEXO06104  
430W - 110 lm/W - 2428 × 5601 × 33 mm 6500°K

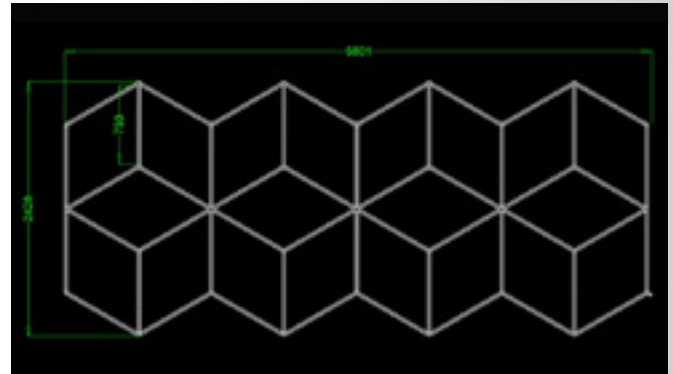

CL-LED géométrique ST61HEX002  
589W - 120 lm/W - 2796 x 4828 x 33 mm- 6500°K

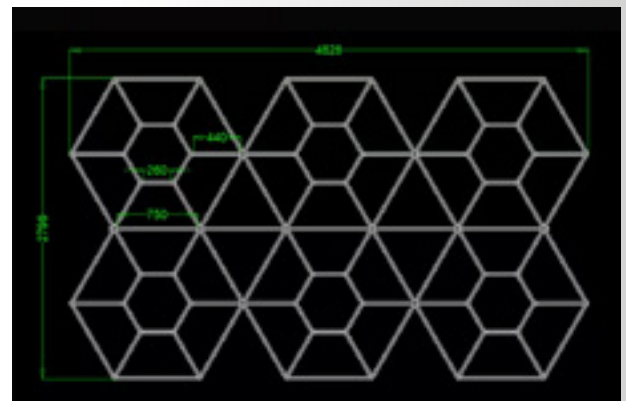

# HEXORA - NID D'ABEILLES

Gamme SHX



## CL-Nid d'abeilles SHXHEXO12

368W - 120 lm/W - 3000 x 4200 x 20 mm - IP 44 - 6500°K

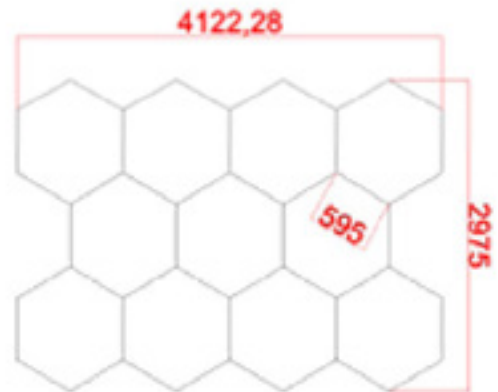

## CL-Nid d'abeilles SHXHEXO03

168W - 120 lm/W - 3900 x 1550 x 20 mm - IP 44 - 6500°K



# HEXORA - NID D'ABEILLES

Gamme SHX



## CL-Detailing SHXHEX005

240W - 120 lm/W - 2975 x 3091 x 20 mm - 6500°K

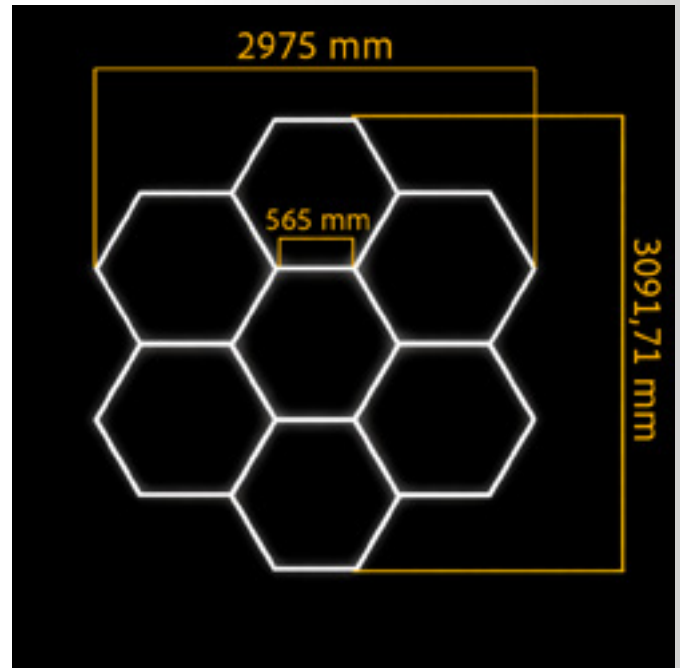

## CL-Detailing SHXHEX008

432W - 120 lm/W - 4750 x 3000 x 20 mm - 6500°K



# HEXORA - NID D'ABEILLES

Gamme SHX



## CL-Detailing SHXHEX021

288W - 120 lm/W - 4200 x 4150 x 20 mm - 6500°K

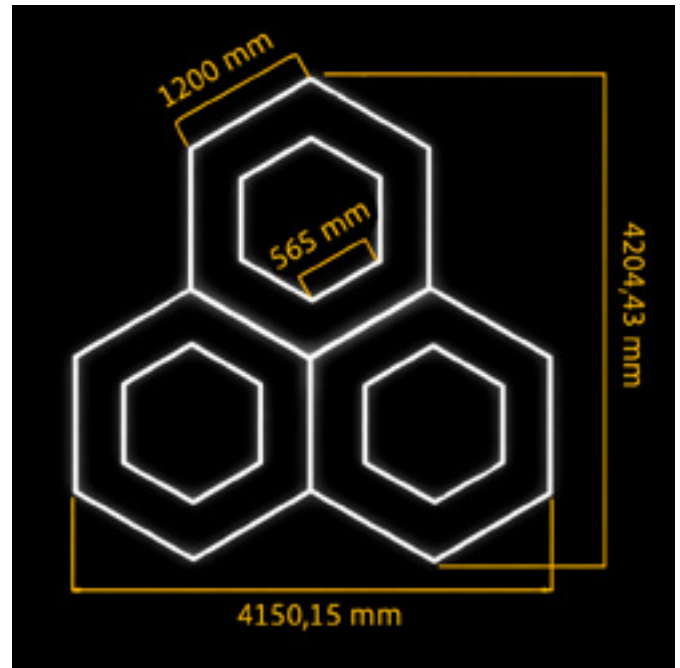

## CL-Detailing SHXHEX022

312W - 120 lm/W - 6200 x 2400 x 20 mm - 6500°K

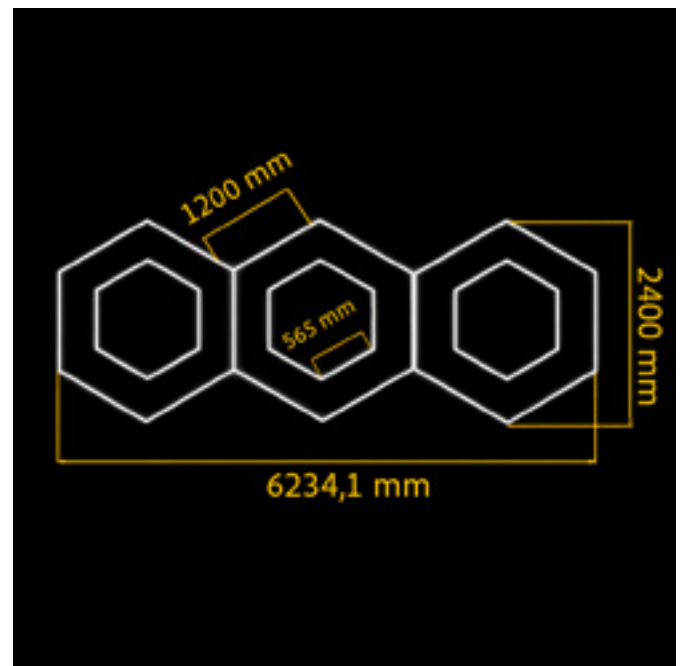

# HEXORA - NID D'ABEILLES

Gamme SHX



## CL-Detailing SHXHEXO24

128W - 120 lm/W - 3350 x 850 x 20 mm - 6500°K

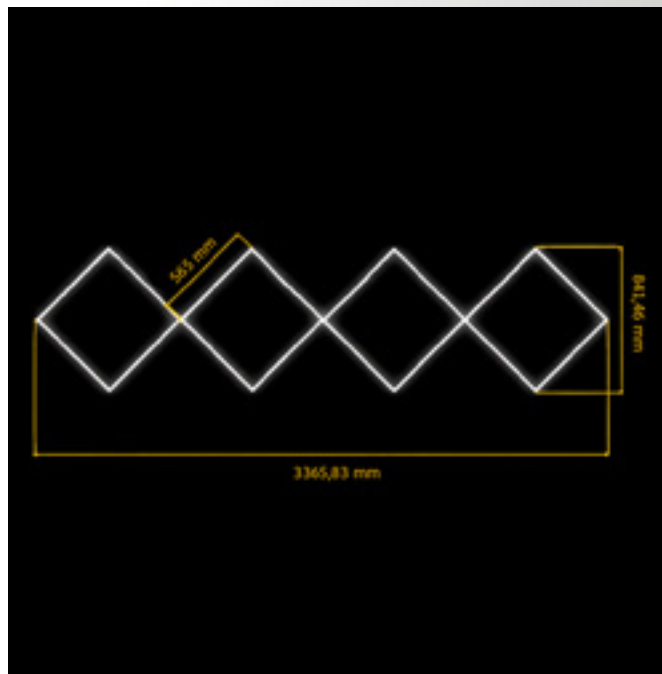

## CL-Detailing SHXHEXO 25

193W - 120 lm/W - 2500 x 1680 x 20 mm - 6500°K

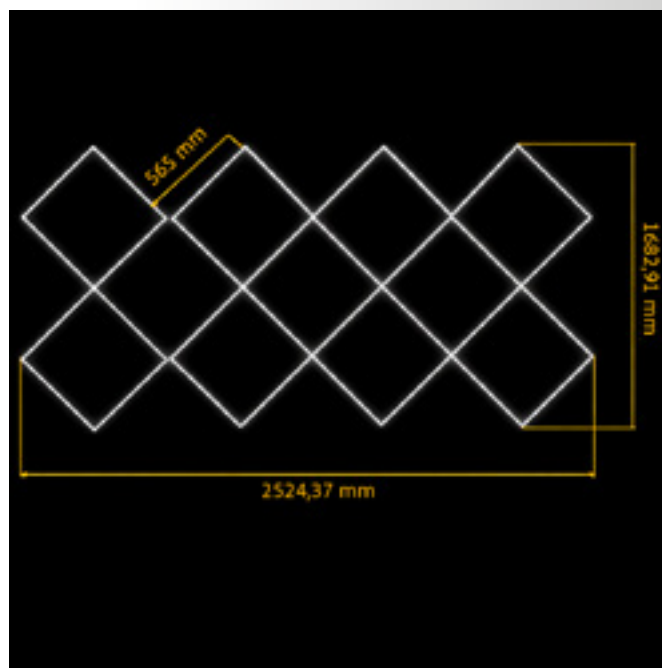
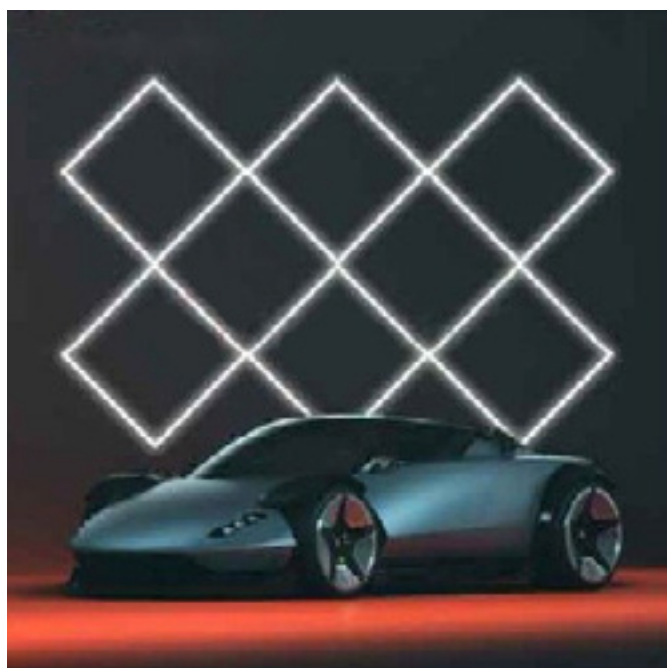

# HEXORA - NID D'ABEILLES

Gamme SHX



## CL-Detailing SHXHEX026

120W - 120 lm/W - 2380 x 600 x 20 mm - 6500°K

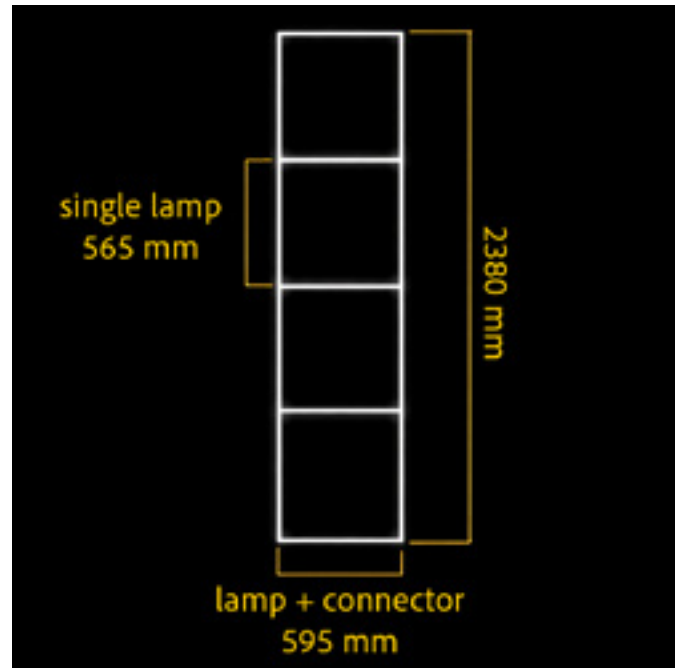

## CL-Detailing SHXHEX027

192W - 120 lm/W - 2380 x 1200 x 20 mm - 6500°K

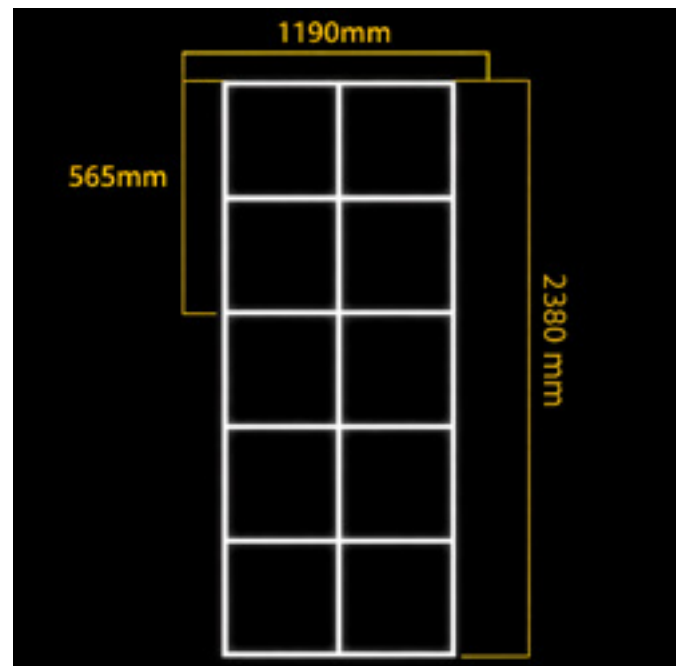



CL-Detailing Gamme Pro LED STHEXO1028  
552W - 120 lm/W - 2410 x 4780 x 20 mm -6500°K

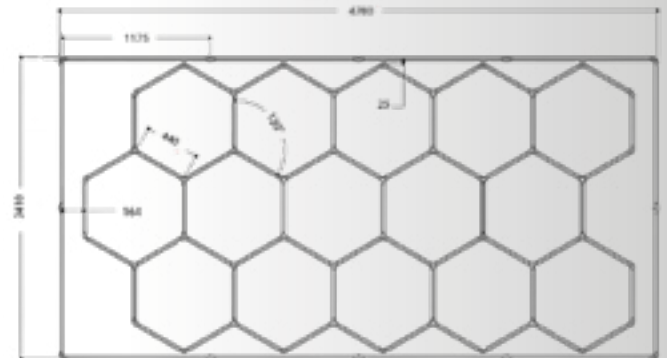
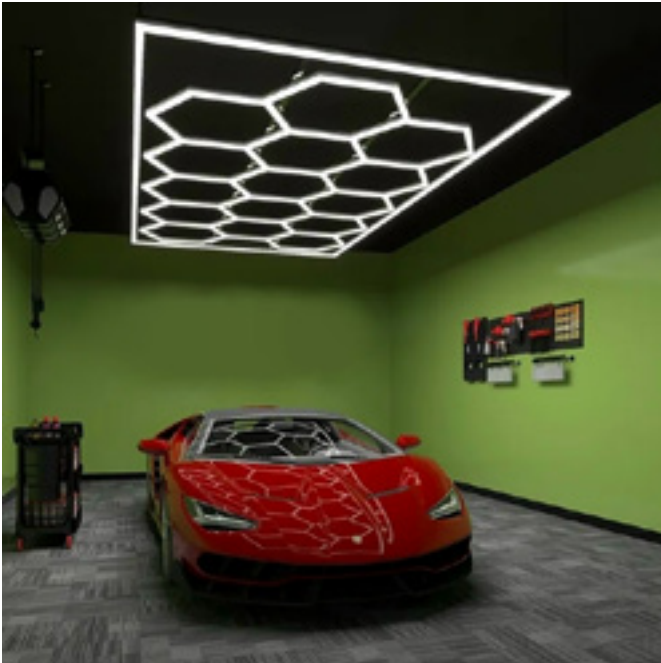

CL-Detailing STHEXO2018  
512W - 120 lm/W - 2410 x 4780 x 20 mm -6500°K

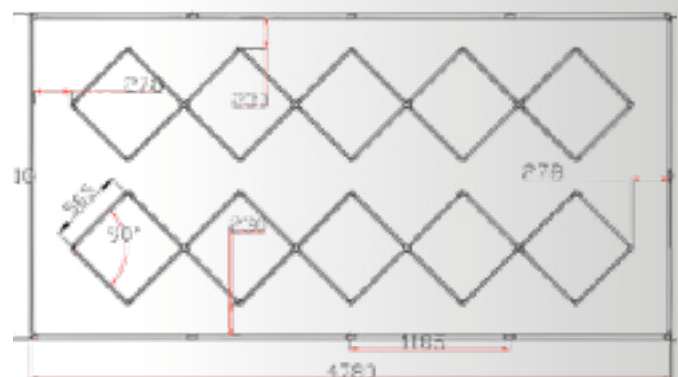

# HEXORA - CADRES



## CL-Detailing SSHXHEXO5028

830W - 120 lm/W - 2350 x 4710 x 80 mm -6500°K

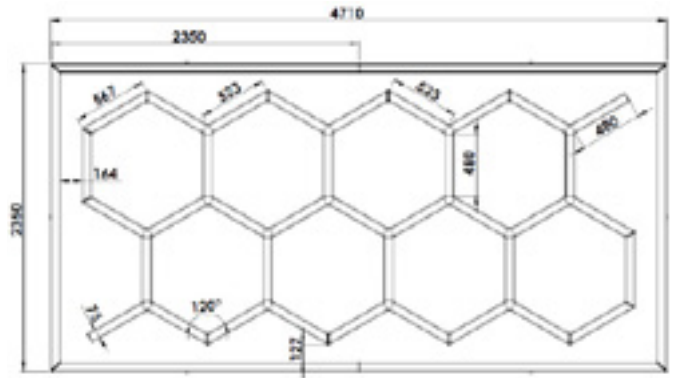

## CL-Detailing STHEXO5058

638W - 120 lm/W - 2350 x 4710 x 80 mm -6500°K

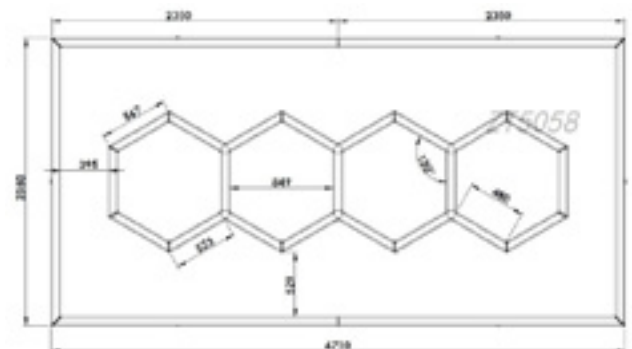
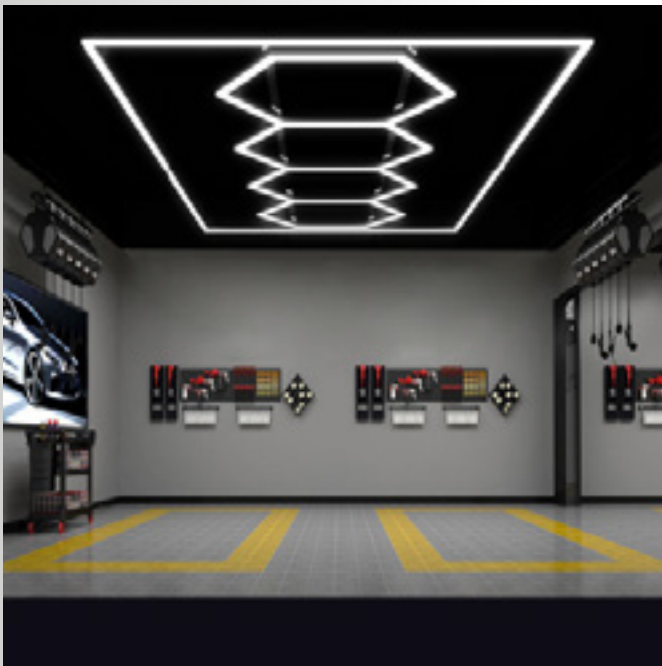



## CL-Detailing SSHXHEXO5068

658W - 120 lm/W - 2350 x 4710 x 80 mm - 6500°K

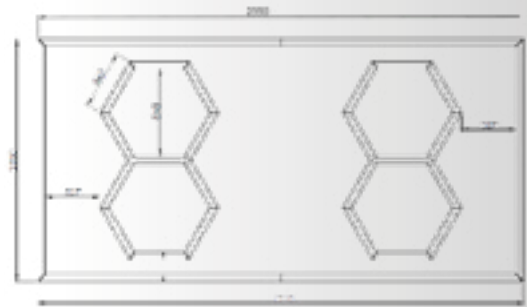

## CL-Detailing SSDLHEXO5078

600W - 120 lm/W - 2350 x 4710 x 80 mm - 6500°K

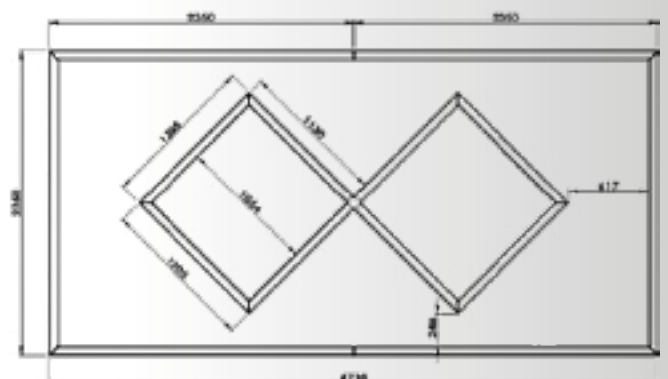
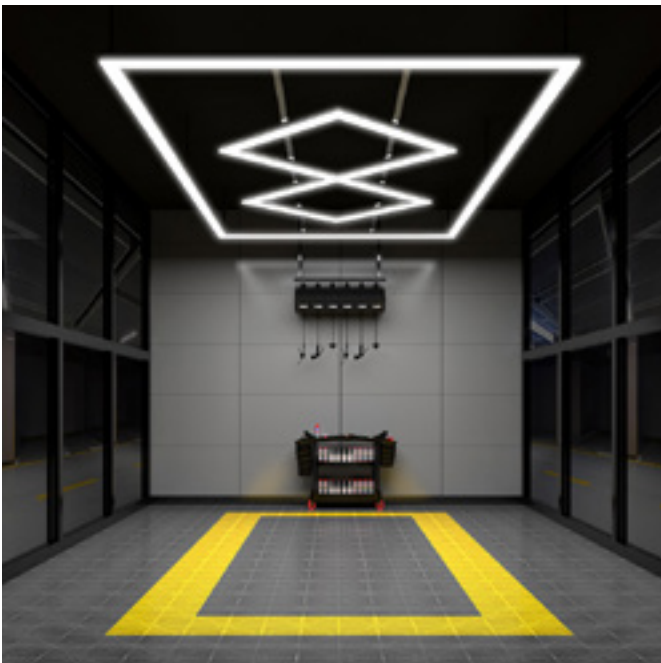



## CL-Detailing SSDLHEXO5088

600W - 120 lm/W - 2350 x 4710 x 80 mm -6500°K

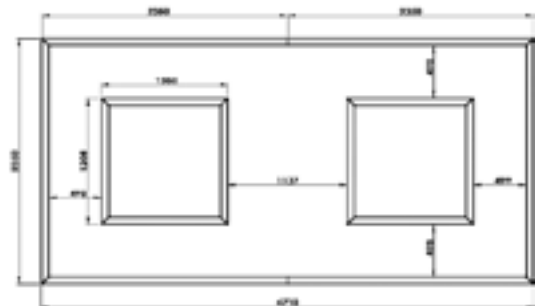

## CL-Detailing SSDLHEXO2058

340W - 120 lm/W - 2410 x 4780 x 20 mm -6500°K

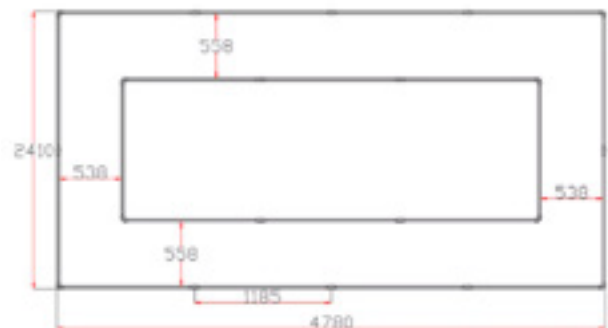
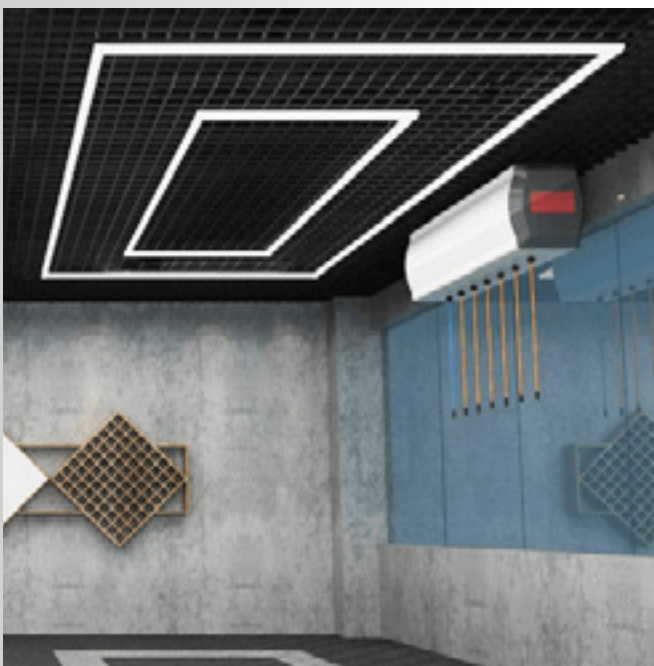



## CL-Detailing SSDLHEXO2048

508W - 120 lm/W - 2410 x 4780 x 20 mm -6500°K

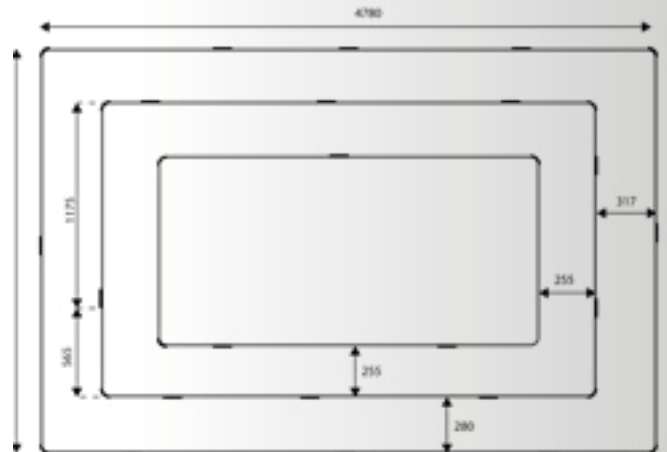

## CL-Detailing SSDLHEXO5098

593W - 120 lm/W - 2350 x 4710 x 20 mm -6500°K

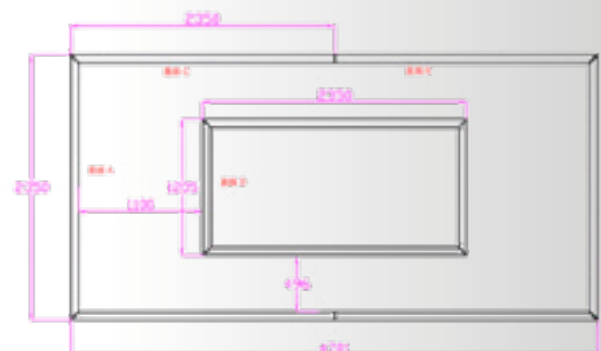
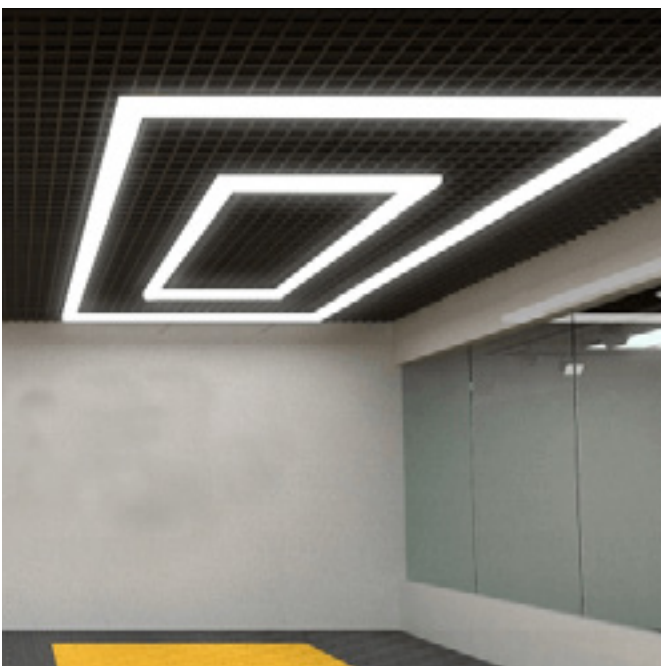

# HEXORA - CADRES



## CL-Detailing SSDLHEXO5018

760W - 120 lm/W - 2350 x 47100 x 10 mm - 6500°K

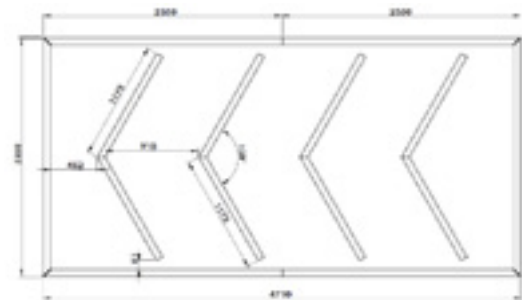

## CL-Detailing SSDLHEXO3018

120W - 120 lm/W - 2100 x 2100 x 20 mm - 6500°K

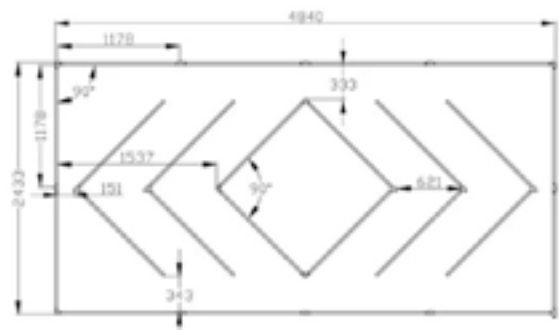



## CL-Detailing SSDLHEXO2078

306W - 120 lm/W - 2410 x 4780 x 20 mm - 6500°K

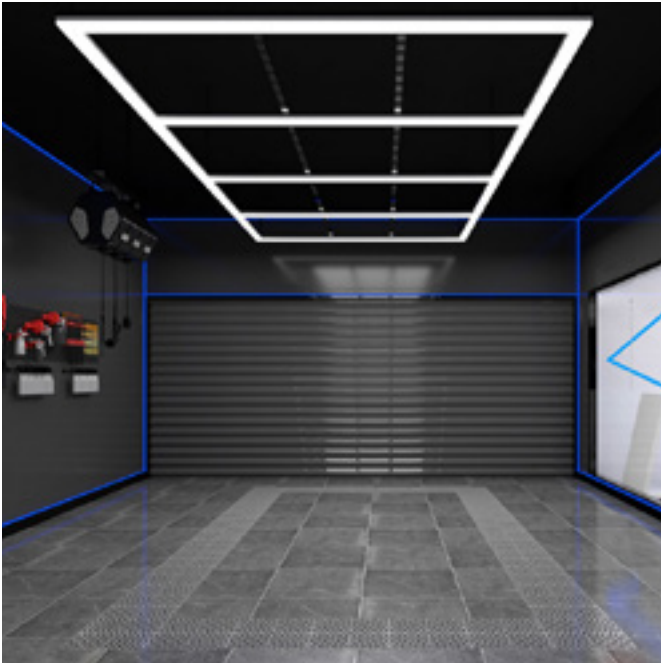

## CL-Detailing SSDLCHEXO80

120W - 120 lm/W - 2100 x 2100 x 20 mm - 6500°K

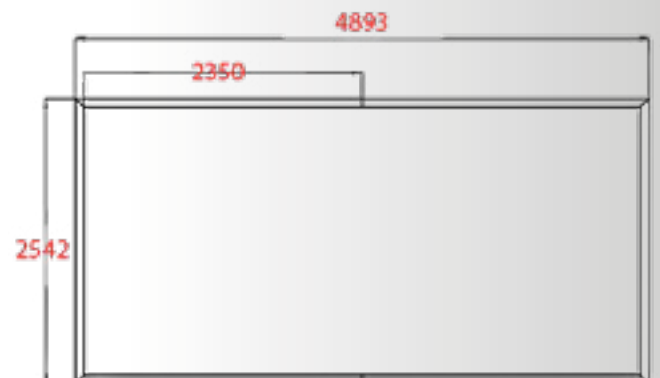



CL-Detailing LED SSDLCHEXO100  
60 W/M - 120 lm/W - 2400 x 4800 x 80 mm - 6500°K





CL-Detailing Tunnel SSLTEHEXO1011  
24 W/M - 120 lm/W - 80 mm d'épaisseur - 6500° K

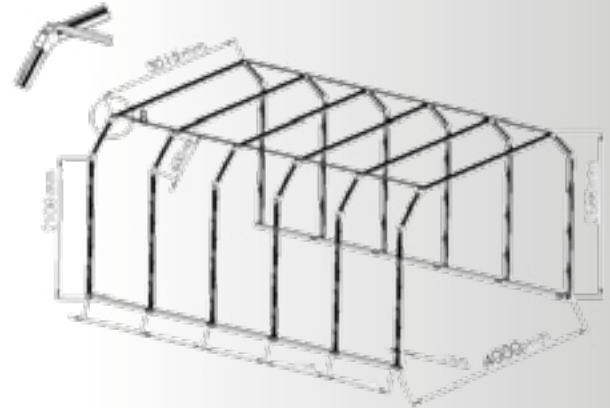

CL-Detailing Tunnel RGB SSLTEHEXO10011  
24 W/M - 120 lm/W - 80 mm d'épaisseur - 6500° K

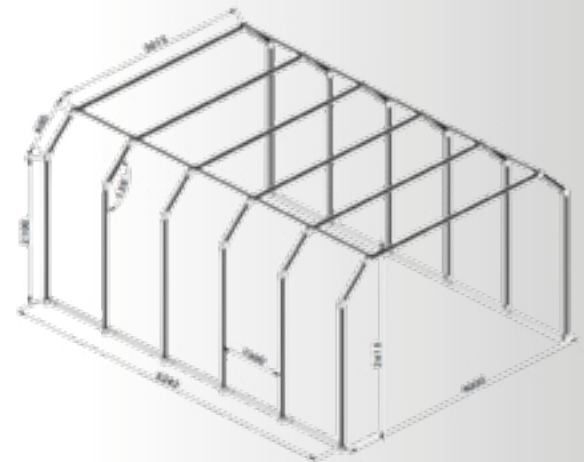



CL-Detailing SSHXCHEX0503 (composable à la demande)  
160W/pcs - 120 lm/W - 1152 x 80 mm - 6500°K

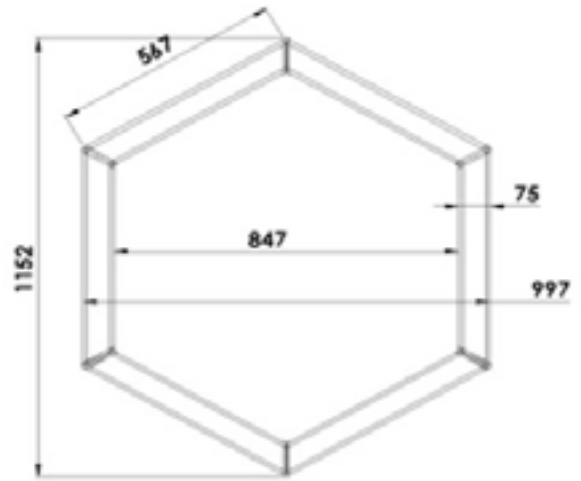

CL-Detailing chevrons LED STCHEX0505  
115W/pcs - 120 lm/W - 80 mm/120° - 6500°K

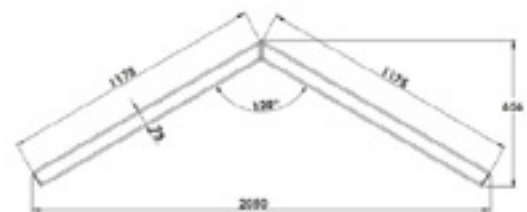



CL-Detailing chevrons LED STCHEXO205  
32W/pcs - 120 lm/W - 20 mm/120° -6500°K

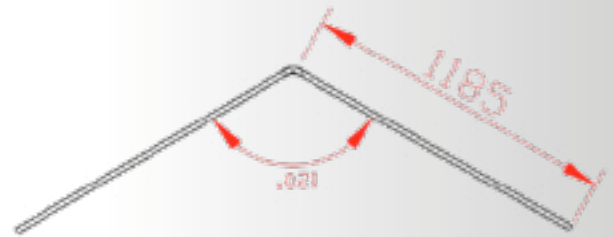

CL-Detailing Gamme Pro LED SLMCHEXO09 (rose)  
48W - 120 lm/W - 1200 x 1050 x 20 mm -LED rose

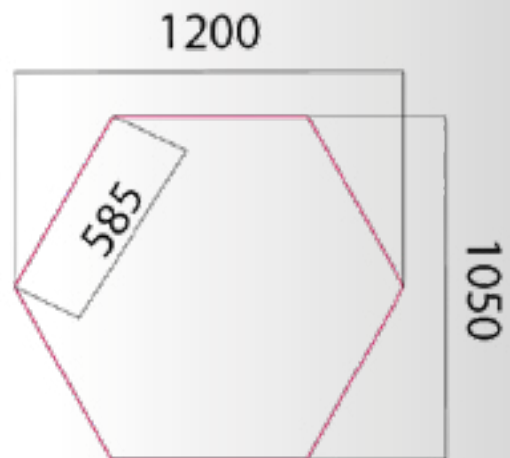

## HEXORA - CUSTOMISABLES



CL-Detailing Gamme Pro LED SLMCHEMA010 (bleu)  
48W - 120 lm/W - 1200 x 1050 x 20 mm -LED bleue

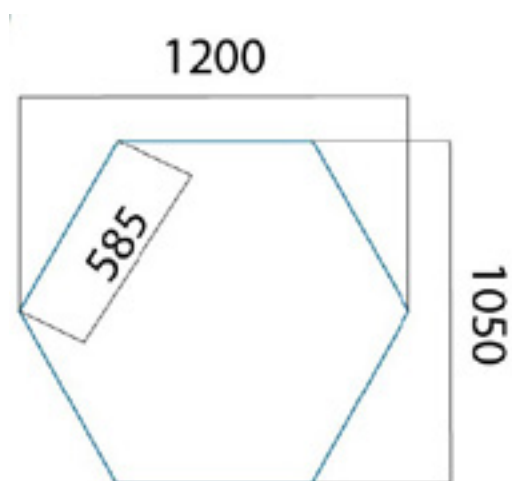

## HEXORA - ACCESSOIRES ET OPTIONS



Les modèles RGB sont fournis avec une télécommande permettant de piloter facilement les couleurs, l'intensité et les modes d'éclairage.

Une solution intuitive pour créer des ambiances lumineuses sur mesure.





CL-Kit filin de suspension detailing  
Ajustement du luminaire possible de 100 à 2950 mm



## NOUVEAU !

Tubes dimmables pour produits de 20 mm d'épaisseur  
Nouveaux CCT \* selon les structures



Liste des produits compatibles :

- ◇ L'ensemble de la gamme SHX
- ◇ Chevrons STC205
- ◇ Cadres ST2078, ST3018, ST2048, ST2018, ST1028

Avantages :

- ◇ Protection environnementale
- ◇ Économie d'énergie

Contactez-nous pour toute étude ou demande spécifique.

\* CCT : différentes températures de couleur (Kelvin) disponibles sur demande.



## Comparatif qualitatif



## Tubes et connecteurs (V et Y)

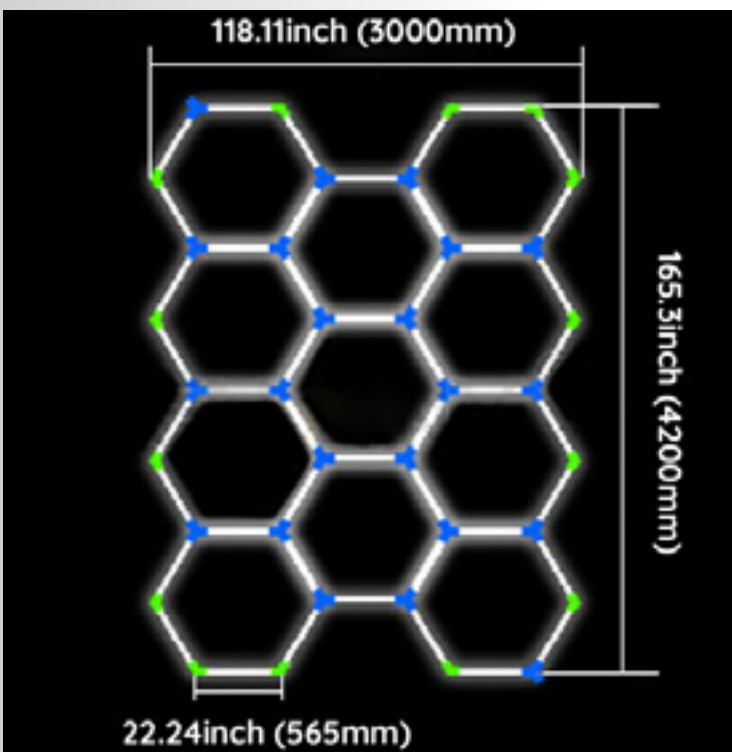

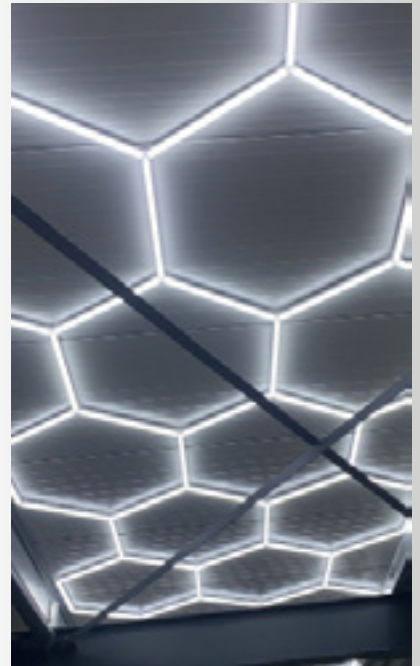



Nous concevons des configurations sur mesure, adaptées à vos projets et à vos exigences esthétiques.

Découvrez quelques mises en lumière pour vous inspirer.



*Ensemble sur-mesure de 8 hexagones*



*Symétrie de 7 hexagones*



*Composition circulaire complexe de 10 hexagones*



*Composition modulaire de 6 hexagones*



*Ensemble complexe de 10 hexagones*



*Composition complexe de 13 hexagones*

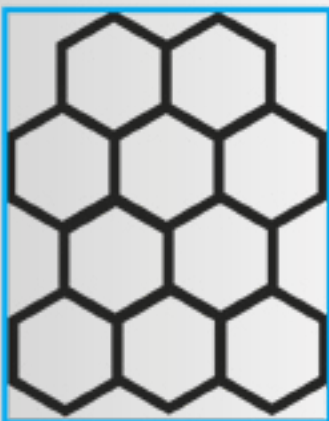

*Ensemble de 10 hexagones avec cadre bleu*

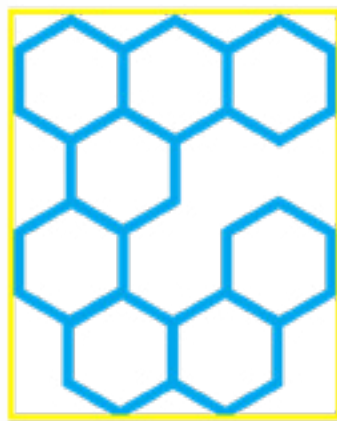

*Composition de 8 hexagones bleus avec cadre jaune*



*Ensemble de 6 hexagones roses*



Chaque création s'adapte à vos envies, vos contraintes et votre vision pour donner vie à des réalisations uniques et impactantes.



*Lettrage C composé de 7 éléments*



*Lettrage C composé de 7 éléments avec cadre rouge*



*Composition libre de 10 hexagones*



*Structure asymétrique de 9 hexagones*



*Lettrage H composé de 9 hexagones*



*Composition complexe de 12 hexagones*



*Structure simple de 7 hexagones*

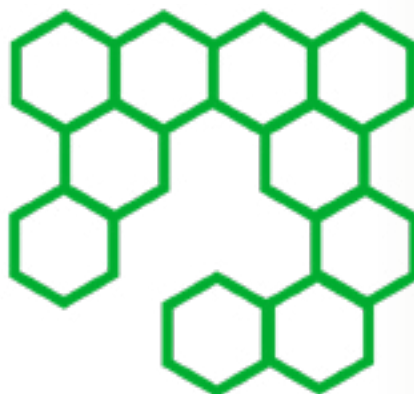

*Ensemble de 10 hexagones verts*

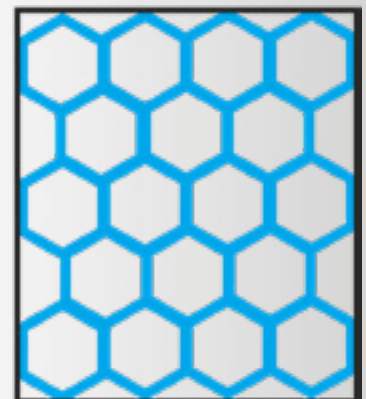

*Composition compacte de 18 hexagones bleus et son cadre*



Au-delà du detailing automobile, nos solutions permettent de créer des ambiances lumineuses uniques pour tous types d'espaces.

Du secteur automobile aux salles de sport, en passant par les stands, nous vous accompagnons dans la mise en valeur de vos projets.

Grâce à notre large gamme de produits et à nos solutions sur mesure, chaque idée peut prendre vie avec précision, créativité et exigence.



*Réalisation décorative  
Luminaires CL hexagone One Mono*



# HEXORA - MISE EN LUMIÈRE

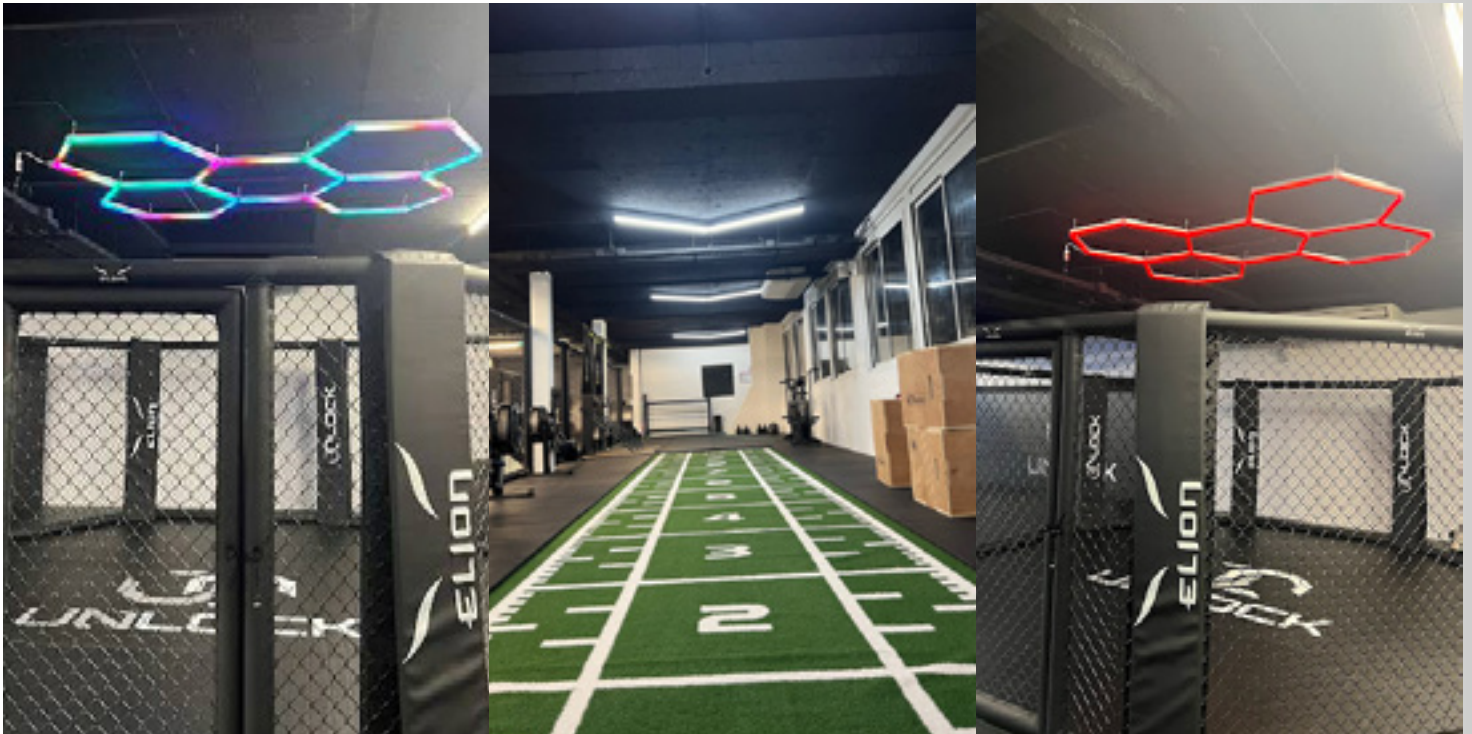

*Mise en lumière de la salle de sport Unlock (Paris 17ème)  
Cadres LED SSDLHEXO2058, hexagones RGB05, RGB 01 et chevrons STCHEXO205*



Mise en lumière du salon de coiffure Darras (Osny)  
Cadres LED SSDLHEXO2058

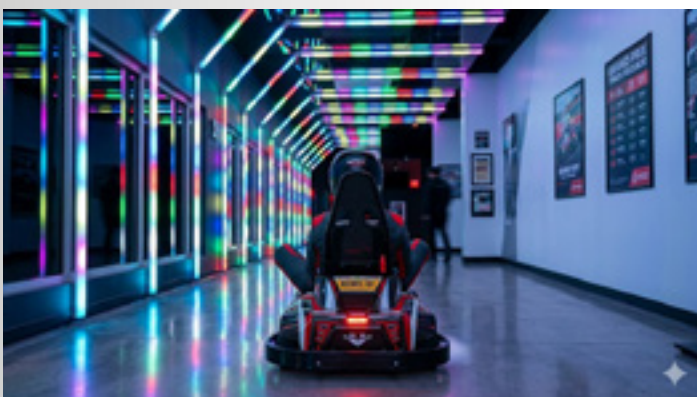

Aménagement d'un circuit de karting  
Tunnel RGB SSLTEHEXO10011



Réalisation décorative du salon de coiffure Projectyon (Deux-Sèvres)  
Cadres LED SSDL.CHEXO80





*Mise en lumière de véhicules prestigieux  
Centre Porsche (Limoges)  
Composition sur-mesure*



*Mise en lumière d'un salon de coiffure  
Luminaire ST6103T*

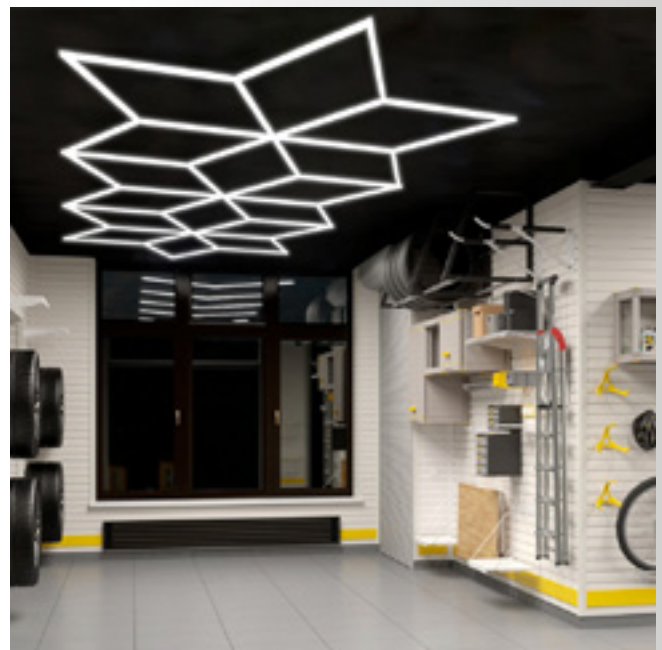

*Mise en lumière d'un garage  
Luminaire ST6103T*

# HEXORA

par



Concept Light, spécialiste de l'éclairage automobile depuis 1994, met son expertise au service de vos projets.

À travers sa marque HEXORA, nous développons des solutions lumineuses innovantes, pensées pour sublimer vos espaces et renforcer votre identité visuelle.

Pour une expérience complète, pensez également à intégrer le son et la vidéo afin de créer des ambiances immersives autour de vos produits et outils de communication.

## CONTACT

Concept Light  
ZA - 8 Rue des Alpes  
68127 Niederhergheim

03 89 21 09 15  
[info@conceptlight.fr](mailto:info@conceptlight.fr)

